

S300 FOLDING TREADMILL

INSTRUCTION MANUAL

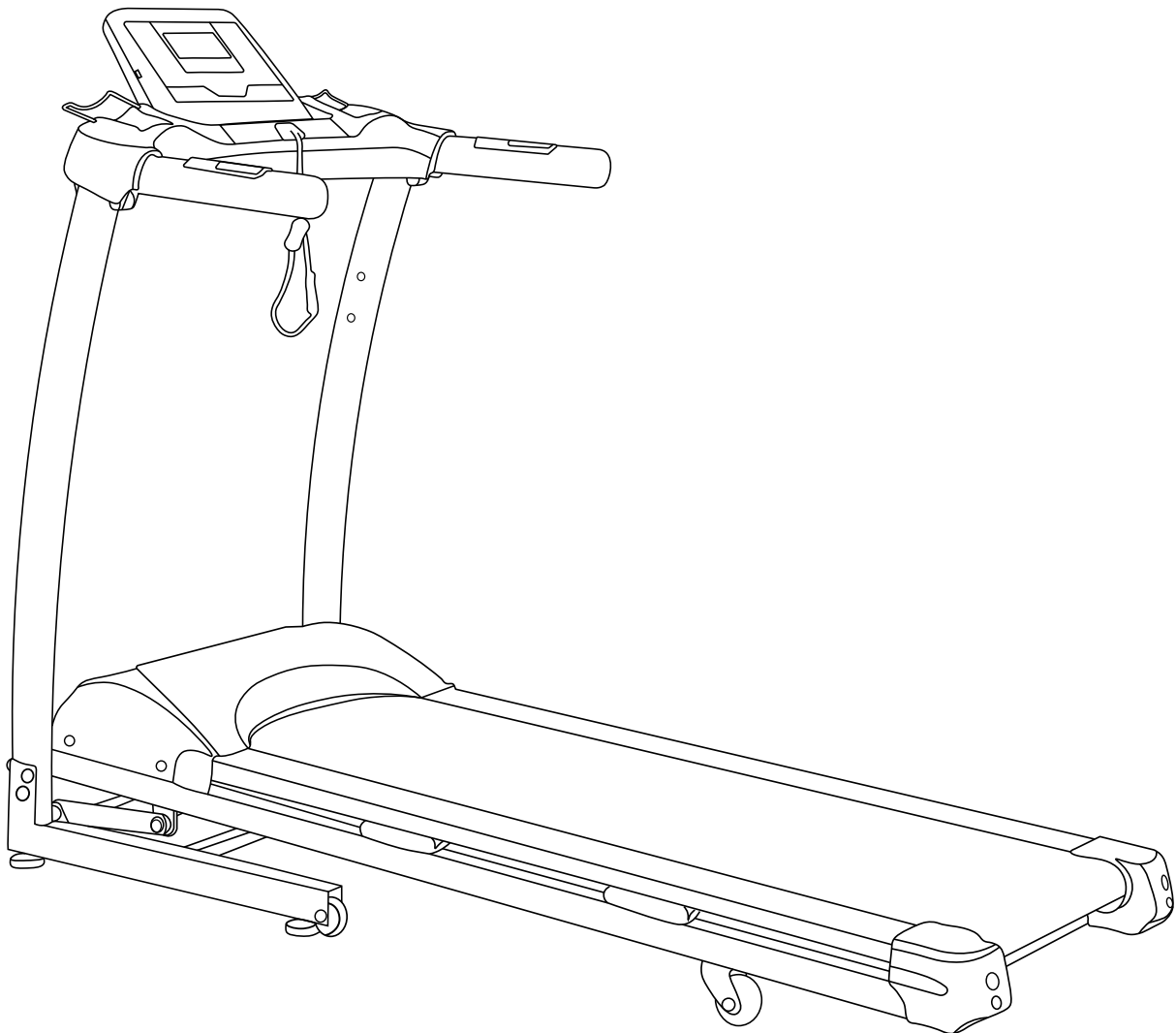

Scan the QR code for a step-by-step video guide on how to assemble your treadmill.

Scan the QR code to view our support center for more technical resolutions and FAQ's about your item.



CONTENTS

1. SAFETY INSTRUCTIONS

Electrical requirements	4
Important voltage information	4
User safety precautions	4
Prior to use.....	4
During use.....	5
Exercise safety precautions	5
Facility safety precautions	5
Safety key	6
Warning stickers	7

2. ASSEMBLY

Preparing the site	8
Diagram	8
Content listing	9
Box contents.....	9
Accessories box.....	9
Tools pack.....	9
S300 assembly	10
Folding & unfolding the treadmill	13
Setup options	13
Monitor configuration	14
Display information	14
LCD brightness adjustment	15
Testing the treadmill operation	15
Specifications	16

3. OPERATION

Control symbols used	17
Setup	18
Setup parameters.....	18
Pause/Stop.....	18
Setup incline.....	18
Quick speed.....	18
Total distance shown.....	18
Exit setup mode.....	18

Starting the treadmill	19
Stopping the treadmill	19
Emergency dismount.....	19
Safety key function.....	19
Heart-rate sensors	20
Data readouts	20
Entertainment	20
Play your MP3/Smartphone/Tablet device.....	20
USB audio interface.....	20
Programs	21
Custom programs.....	21
Heart-rate control program.....	21
Preset programs.....	21

4. MAINTENANCE

Preventive maintenance activities	24
Treadmill cleaning	25
Treadmill balance	26
Treadmill lubrication	27
5 steps to lubricate your treadmill.....	27
Adjusting the running belt	27
How to check if the running belt is loose.....	28
Tightening the running belt.....	28
Adjusting the belt when it's not centred (bear left or right).....	29
Adjusting the motor belt	30
How to check if the motor belt is loose.....	30
Tightening the motor belt.....	31

5. ADDITIONAL INFORMATION

Additional information	32
Disclaimer	32

1 Safety Instructions

Please pay attention to the following instructions before operating this treadmill.

ELECTRICAL REQUIREMENTS

This treadmill must be earthed and plugged into an appropriate electrical outlet that is properly installed and earthed in accordance with all local codes and ordinances.

This treadmill is for use on an earthed, dedicated circuit. Make sure that the treadmill is connected to an outlet having the same configuration as the plug. Do not use a ground plug adapter to adapt the power cable to a non-grounded outlet.

IMPORTANT VOLTAGE INFORMATION

Before plugging the power cable into an electrical outlet, verify that the voltage requirements for the site match the voltage of the treadmill that has been received. The power requirements for the unit include an earthed, dedicated circuit, rated for one of the following. The usual voltage for: United Kingdom is 240V, 50 Hz; Spain is 230V, 50 Hz; Italy is 230V, 50 Hz; Germany is 230V, 50 Hz; and France is 230V, 50 Hz.

⚠ WARNING

- Shock and electrocution hazard.
- Connect unit to an earthed outlet.
- Do not use a voltage adapter.
- Unplug unit and let sit 10 minutes before cleaning or performing maintenance.
- Electrical charge can remain in unit after unplugging.
- Keep water and liquids away from electrical parts.
- Do not attempt to fix electrical faults if unqualified to do so!

USER SAFETY PRECAUTIONS

PRIOR TO USE

- When you first assemble your treadmill make sure to check your running belt before use! This is part of the maintenance and instructions on how to perform this can be found on pg. 27.
- Assemble the treadmill according to the instruction manual.
- Consult your doctor before beginning any exercise program.

- Read instructions.
- Read warning labels.
- Read emergency stop procedures.
- Maximum user weight is 120kg/ 18.8 St.
- Inspect unit. If damaged, DO NOT USE.
- Ensure every bolt and screw is securely tightened.
- Place your feet on the side frames when starting or stopping the treadmill.

DURING USE

- DO NOT use for stretching and DO NOT attach straps or other devices.
- DO NOT allow children aged 12 or younger to be on or near the machine.
- Stop exercising if you feel faint, dizzy, or encounter pain.
- Use the handrails for support and balance, do not use to support a users entire bodyweight.
- Change speed in small increments for safety.
- Keep all clothing and accessories clear of moving parts.
- Wait until the running belt comes to a complete stop before getting off.
- DO NOT jump onto a moving running belt.

EXERCISE SAFETY PRECAUTIONS

- Use sports clothes and gym shoes.
- Check your shoes regularly and see if there is any dust or hard particles attached which may cause unnecessary damage.
- DO NOT use with bare feet.
- This model should only be used at home. DO NOT use for commercial purposes.

FACILITY SAFETY PRECAUTIONS

- Connect the treadmill to a properly earthed outlet only.
 - DO NOT operate electrically powered treadmills in damp or wet locations.
 - Clip the safety key to your clothing.
 - Use caution when getting on or off the treadmill.
 - Keep the running belt clean and dry at all times.
 - After each use, wait until the treadmill comes to a complete stop and is level. Then, switch it off and unplug it. Next remove the emergency safety key from the treadmill.
 - Check the treadmill for worn or loose components before each use. DO NOT use until worn or damaged parts are replaced.
 - Maintain regularly. Refer to *Preventive Maintenance* chapter.
 - DO NOT use the treadmill if: (1) the power cable is damaged; (2) the treadmill is not working adequately or (3) the treadmill has been dropped or damaged.
 - DO NOT place the power cable near heated surfaces or sharp edges.
 - DO NOT use the treadmill outdoors.
-

- DO NOT use the treadmill with 2 or more people running at the same time.
- Read the instruction manual completely before using the treadmill.
- Ensure all users wear appropriate footwear on JLL® equipment.
- Set up and operate the treadmill on a level surface. DO NOT operate in small restricted areas or on plush carpet.
- As far as possible provide the following clearances: 0.5 m at each side and 2 m at the back. Be sure your treadmill is clear of walls, equipment and other hard surfaces.
- DO NOT modify the treadmill in any way. Any modifications will void the warranty.
- All the data displayed by the monitor is for reference purposes only.

SAFETY KEY

The safety key works as an emergency stop. In the event of falling off the treadmill, the safety key will be pulled out and the power will be switched off at once. Be sure the string is free of knots and has enough slack for you to workout comfortably with the safety key in place. Before using the treadmill, clip the safety key to your clothing.

1. Confirm that the safety key is in place in the bottom of the console. The treadmill will not start without the key in its place.
2. Check the safety clip does not fall off in an emergency situation. Carefully step backward until the key pulls out of the console. If the safety clip falls off your clothing, clip the key again to your clothing and repeat this step until the safety clip is properly attached to your clothes.
3. Ensure the safety clip is secured to your clothing at all times during use.
4. After use, remove the safety key from the treadmill.
5. Store the safety clip on the item holder located on the left or right side of the monitor.

WARNING STICKERS

Warning stickers indicate a potentially hazardous situation which, if not avoided, could result in death or serious injury. Carefully read the following caution and warning labels before using the unit.

WARNING

1. Do not leave the treadmill before ensuring the machine has been locked tightly and properly. Keep children away from the folded machine.
2. Please do not fold the treadmill if the lock does not work properly. If this problem occurs, please contact our customer service department.

WARNING

Press the lock with your foot to unfold the treadmill. Ensure there are no children in close proximity.

WARNING

It is strictly forbidden to touch any moving parts of the treadmill.

WARNING

The plug of this treadmill must be earthed. Do not use this treadmill if the plug is not earthed.

WARNING

Please remove the security lock after finishing the assembly.

WARNING

Remove safety key when not in use and store out of reach of children.

WARNING

Using your foot, firmly push against the cylinder to release the folding mechanism.

WARNING

Keep small children and pets a safe distance from treadmill when in use.

2 Assembly

PREPARING THE SITE

To find the ideal location to set up this treadmill, ensure that:

- Area is well illuminated and well ventilated.
- Surface is level.
- There is enough space to access the unit and emergency dismount. If it is possible, keep the following clearances: 0.5 m at each side and 2 m at the back.
- Place the treadmill in an environment with a relative humidity range of 30-50%. Please ensure the temperature is kept constant. Do not use in a moist or damp environment as this may impact on the integrity and performance of the machine.

DIAGRAM

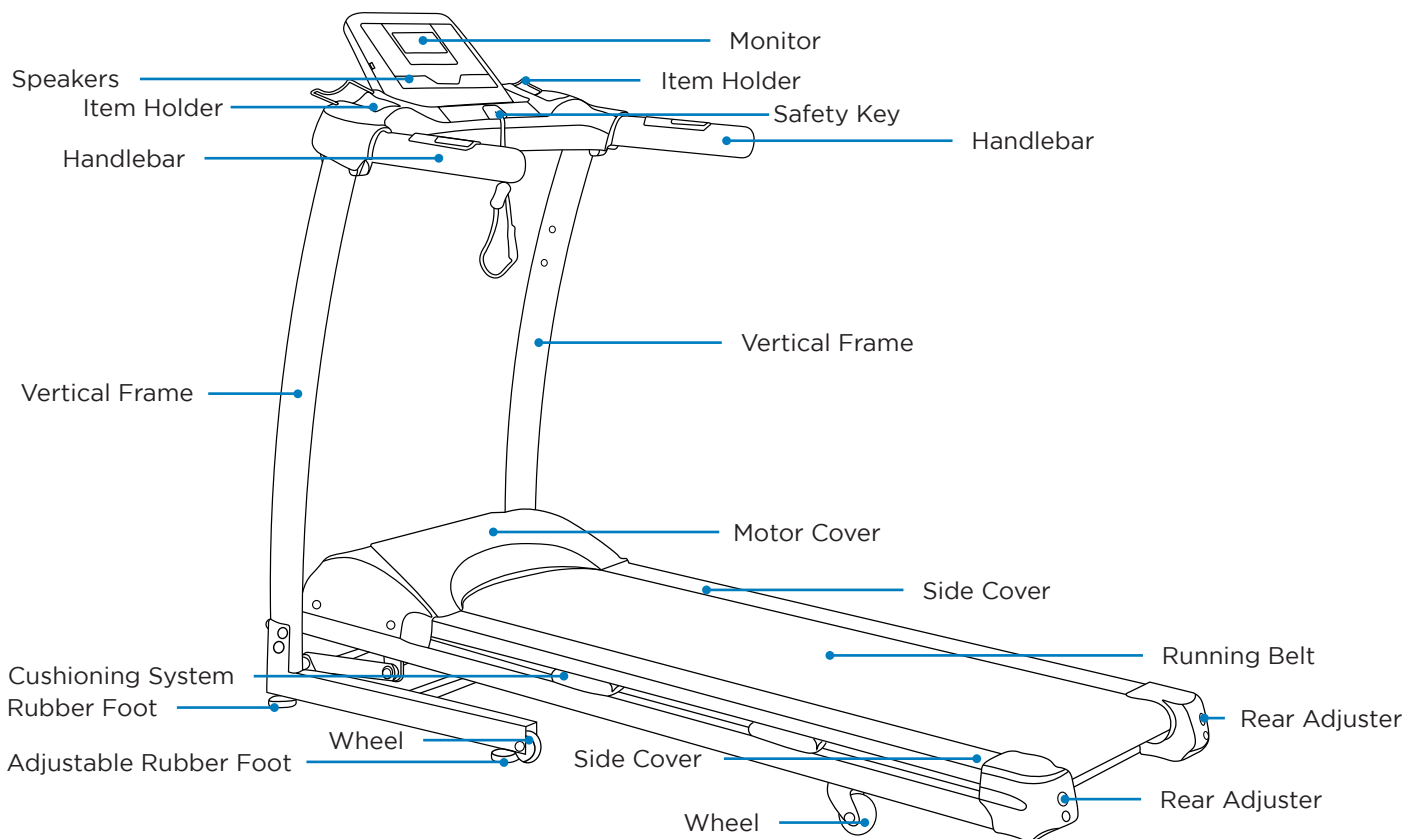

⚠ WARNING: HEAVY EQUIPMENT

- It is recommended that at least two people lift, move and assemble the treadmill.
- Use safe lifting methods.

CONTENT LISTING

See diagram (left) and content listing (below) for treadmill box contents. See *Customer Service* chapter for contact information if any parts are missing.

MAIN BOX

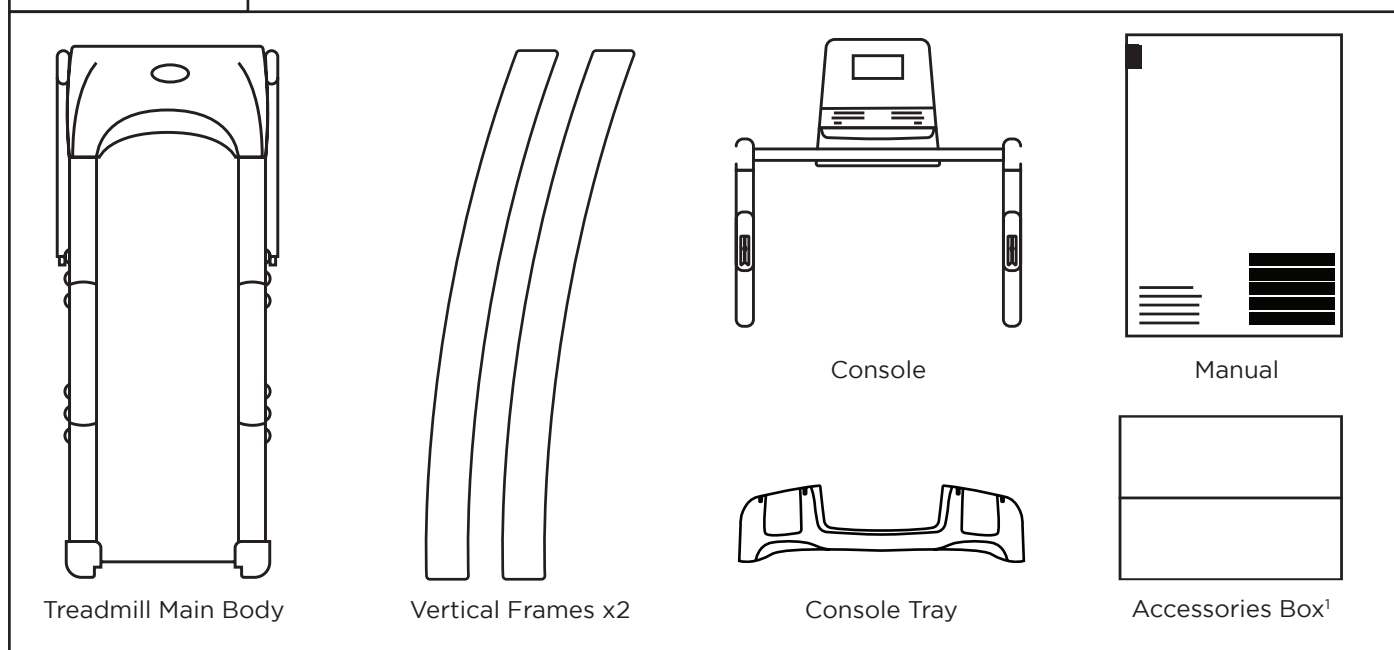

ACCESSORIES BOX

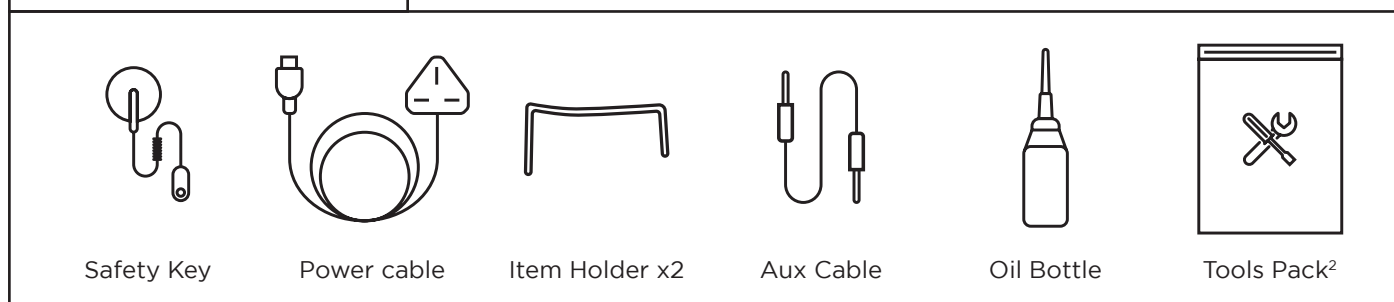

TOOLS PACK

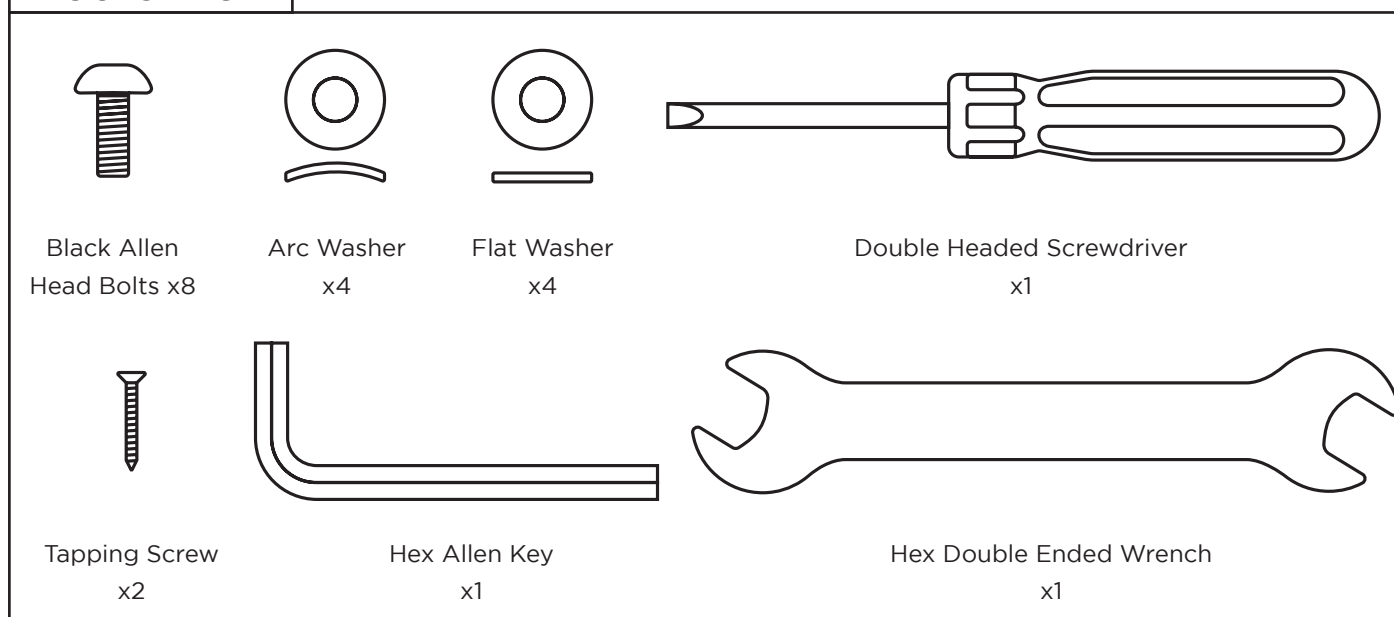

S300 ASSEMBLY

The treadmill has been assembled and tested at the factory, so you shouldn't have any problems putting all the parts together. Components are designed to fit together, and only basic tools are required for the assembly process. Inside the box you will find a Tools Pack (Hex Allen key, Screwdriver, Wrench, Washers and Bolts). See previous page.

To assemble your JLL S300 please follow these easy steps:

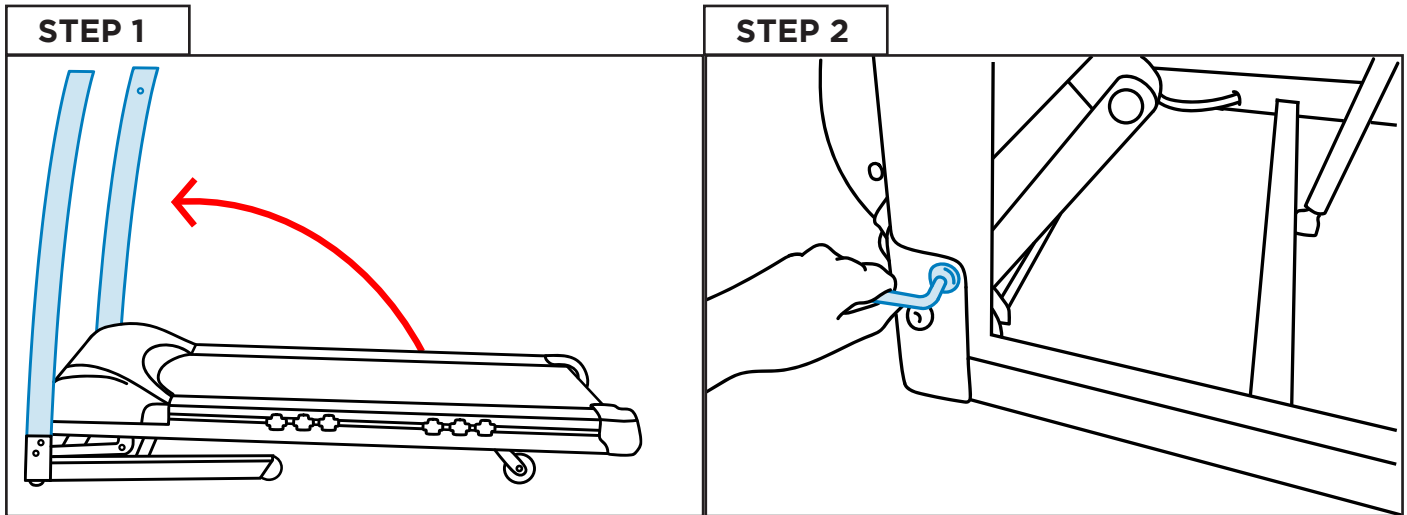

Raise up the vertical frame bars on both sides.

Secure the vertical frame bars to the running deck using 2x flat washers, 1x arc washer and 3x black allen head bolts on each side. Use 1 washer per bolt.

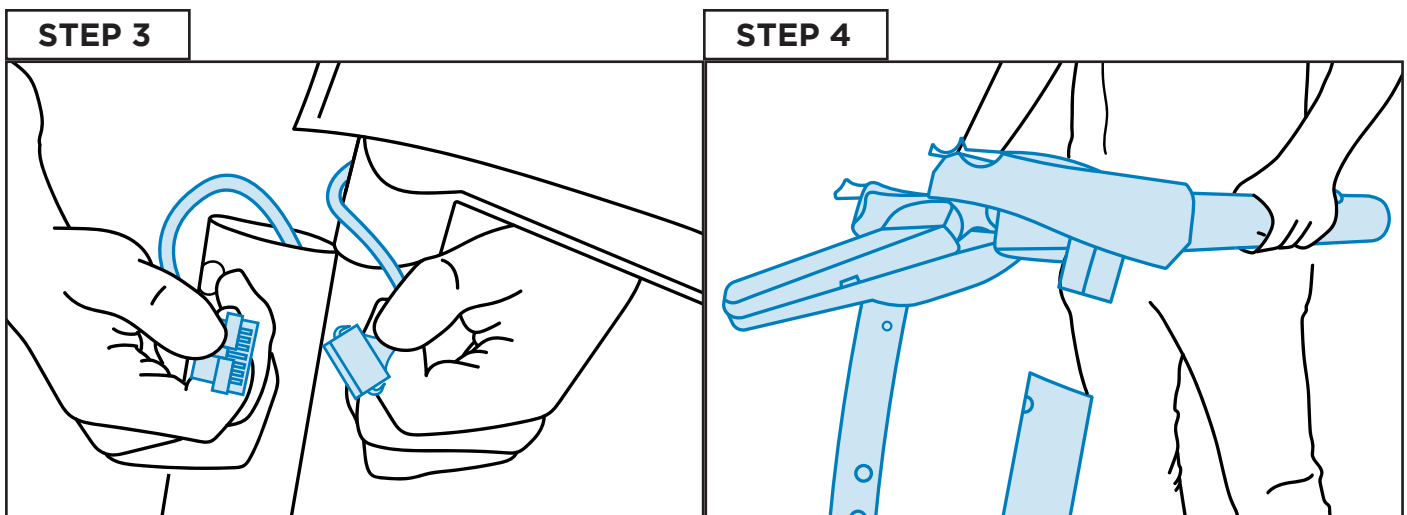

Connect the right hand side wire from the console and the handrail through the plastic clip provided until you hear a clicking noise, then push the excess wire into the handrail frame.

Insert the console into the upper end of the vertical frame bars.

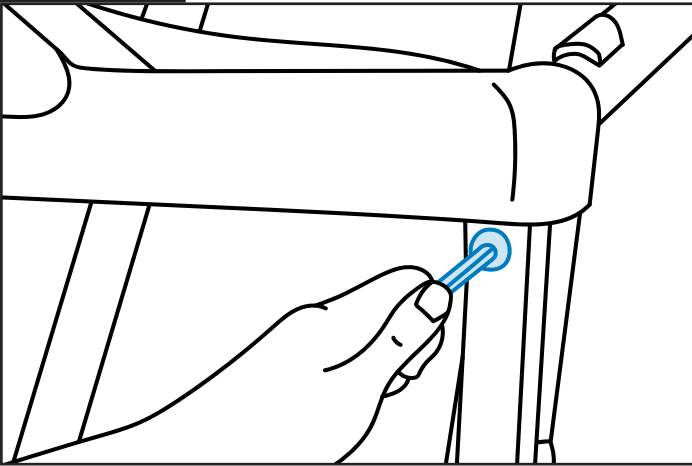
STEP 5

Screw the console to the vertical frame bar. Use 2x black Allen head bolts, arc washers and flat washers.

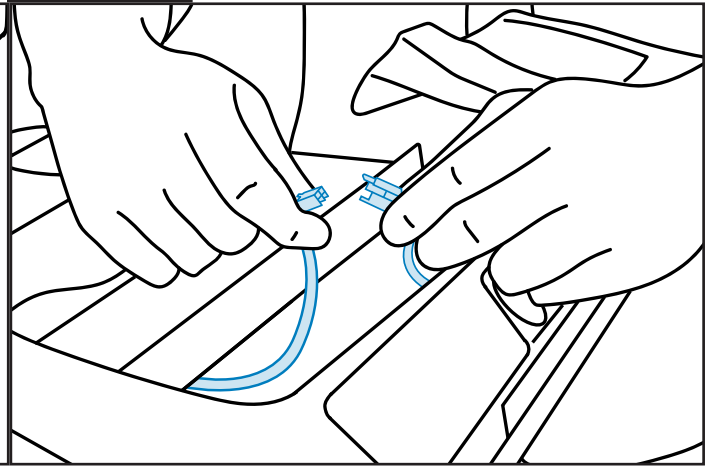
STEP 6

Gently clip the safety key socket wires together ensuring that you do not catch the wire between the console and the frame.

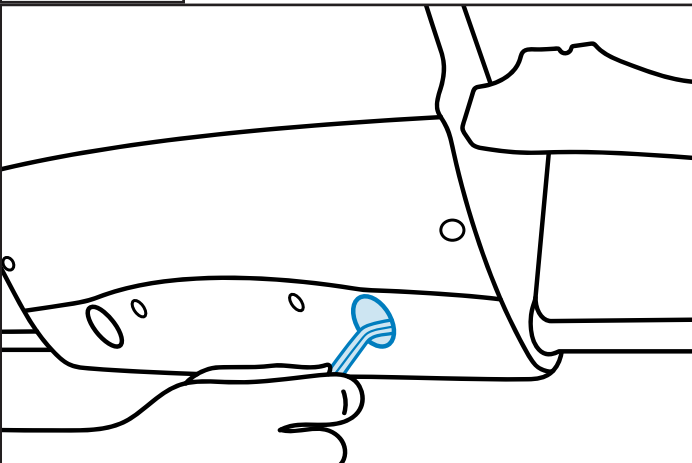
STEP 7

Bring the monitor up towards the tray so that there is no gap between the console and the monitor. Tighten the 2x black Allen head bolts at the rear of the monitor.

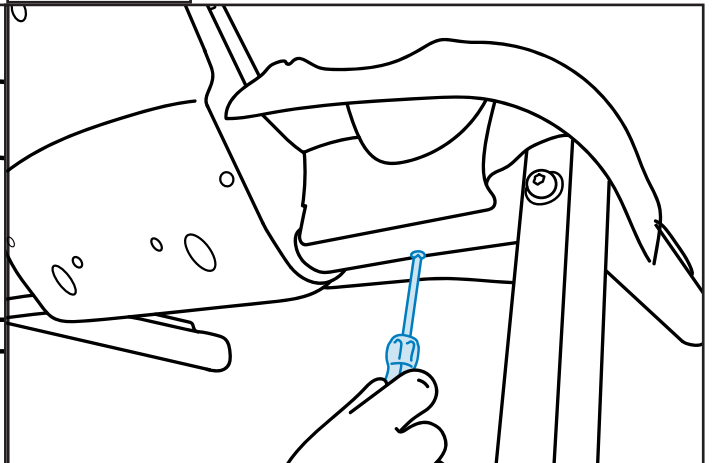
STEP 8

Place the tray onto the console frame. Screw the 2x tapping screws into the two plastic cylinders at the bottom of the tray, into the frame.



For additional assistance when lifting your monitor please scan the QR code for our YouTube tutorial.

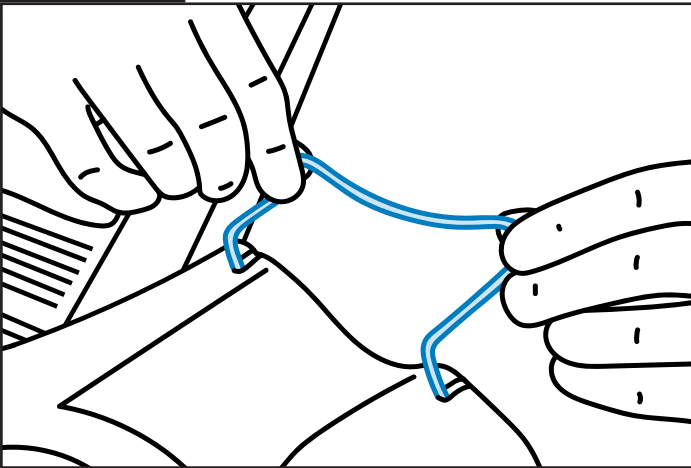

STEP 9

Place the 2x item holders into each side of the tray in the corresponding slots

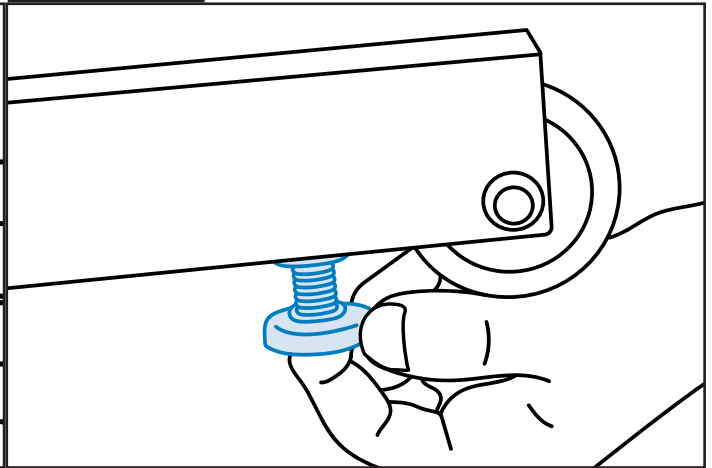
STEP 10

To level the treadmill, adjust the rubber feet at the base if required. Twist the rubber foot anti-clockwise to lower the treadmill or twist clockwise to raise it.

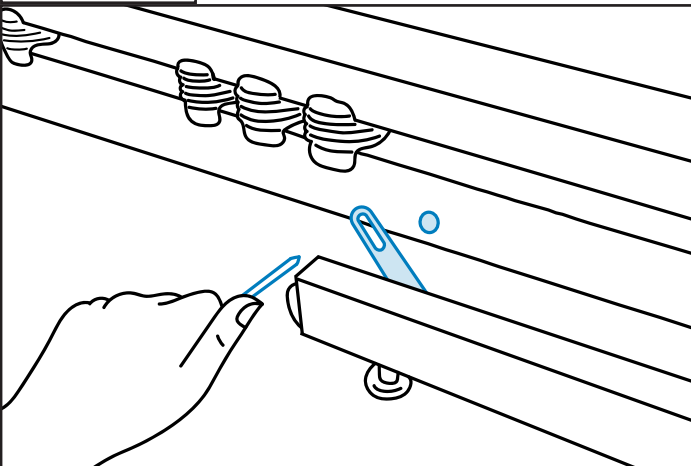
STEP 11

Remove the screw and washers that are attaching the security lock to the base.

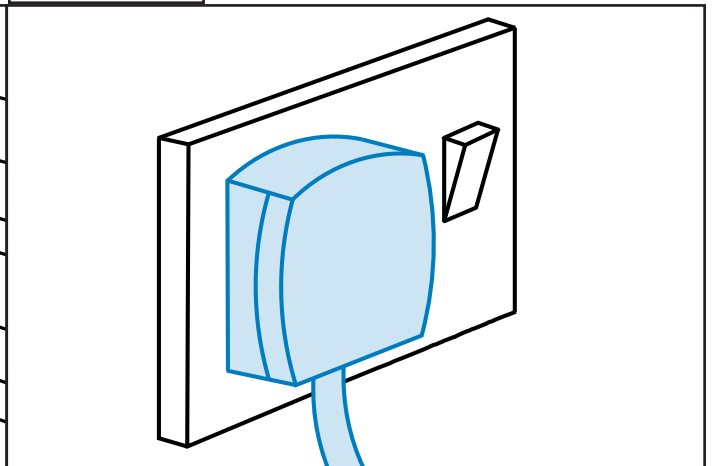
STEP 12

Plug the treadmill into the wall outlet to power on the treadmill.

NOTE: You'll need to insert the safety key in order to operate the treadmill.

FOLDING & UNFOLDING THE TREADMILL

To fold: Hold the end of the running deck, by the side frames/ rails, and lift it until the machine gets an upright position and you hear a click from the hydraulic cylinder.

To unfold: Press the hydraulic cylinder with your foot. Push the running deck down, holding it by the side frames. The running deck will go down slowly thanks to the hydraulic system.

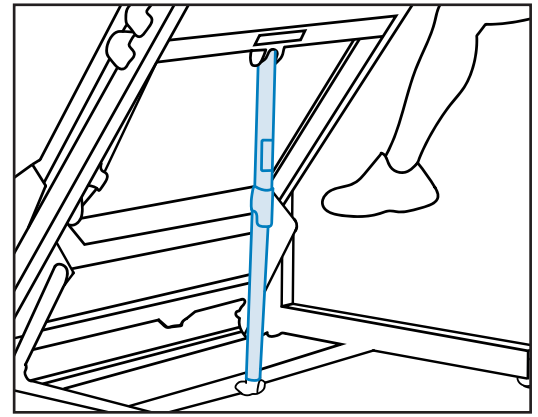

SET UP OPTIONS

Use the following instructions to set up the units settings.

1. Insert the safety key into the corresponding socket.
2. Without anyone on the treadmill, plug in the power cable.
3. Switch on the treadmill. The power switch is under the front end of the machine. The LCD display will light up and all the figures in the window will go to ZERO (0).
4. Introduce the weight that you can see flashing on the right side of the display using the SPEED buttons.
5. Press the START button and the treadmill will start at 0.3 km/h.
6. Press the + and - button to increase or decrease the speed.
7. Press the UP and DOWN button to increase or decrease the incline.
8. Press the STOP button twice to stop the machine and clear the data.

Time Display Range	0:00 - 99:59	Speed Range	0.3 - 16 km/h (0.18 - 10 mph)
Distance Range	0 - 9.999 km	Incline Range	20 Levels
Pulse Display Range	50 - 230 ppm	Programs	15
Calorie Display Range	0 - 999 Kcal	Max. User Weight	120kg, 18.9 St or 264 lb.

To play music from a USB flash drive you should have all music files in MP3 format in a folder titled 'MUSIC' and insert it into the USB port.

On the treadmill press PLAY/PAUSE to play the music. Change the track with SOUND-/LAST and SOUND+/NEXT buttons. To adjust the volume, press and hold SOUND-/LAST or SOUND+/NEXT buttons.

 NOTE: Music needs to be controlled through the device when connected via AUX.

MONITOR CONFIGURATION

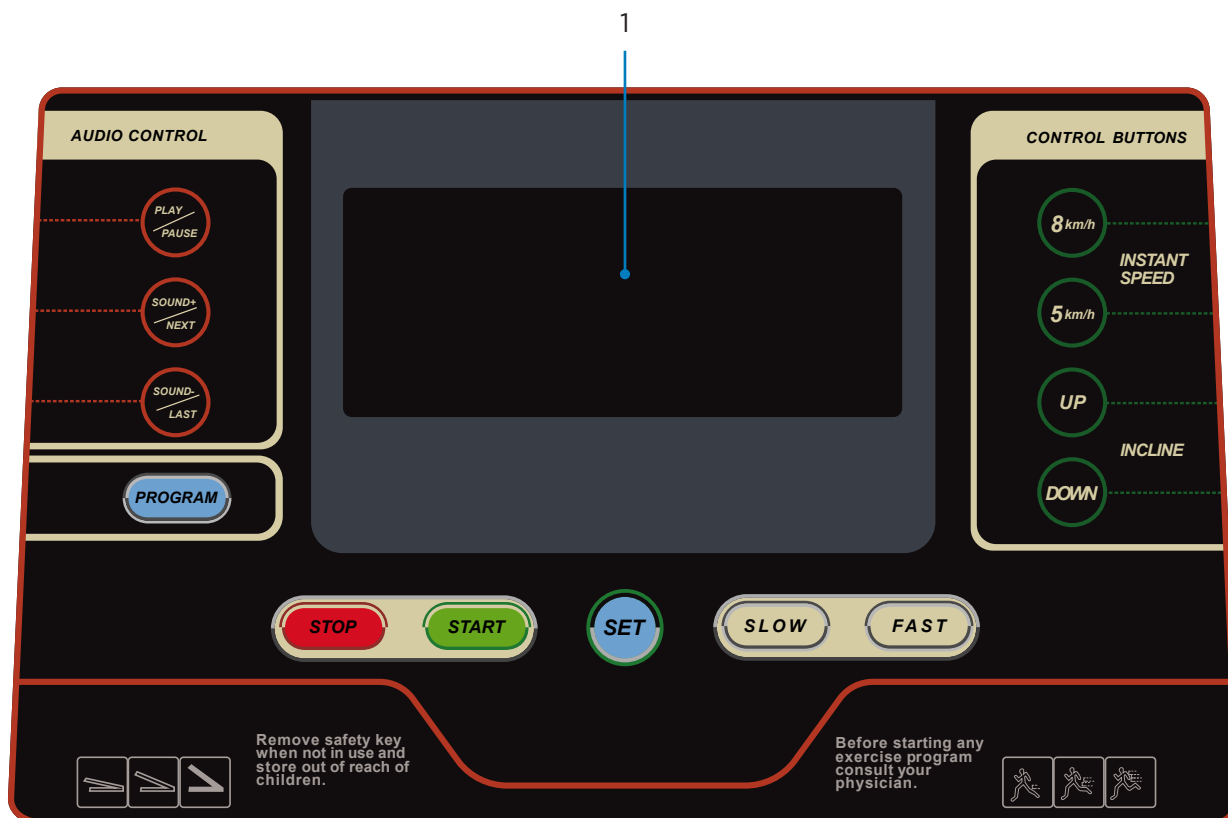

1	LCD display
---	-------------

DISPLAY INFORMATION

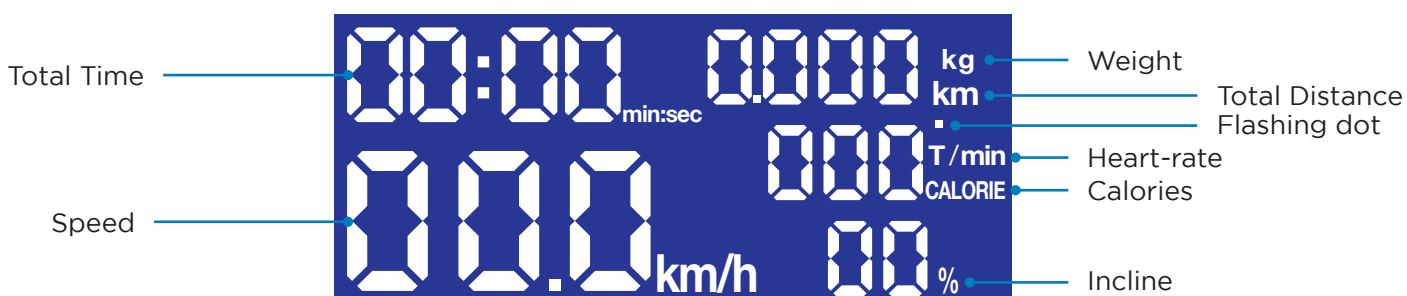

The Weight and Total Distance are shown in the same area of the display. When holding the handlebars a flashing dot will appear on the Pulse signal section on the display and the Calorie reading will change and display your Heart-rate (T/min).

LCD BRIGHTNESS ADJUSTMENT

1. In STANDBY mode, press START and then quickly press STOP. The speed display window will be flashing
2. Adjust the brightness of the LCD display using the FAST or SLOW buttons.
3. Press START to save the adjustments.

TESTING THE TREADMILL OPERATION

Use the following instructions to test the full speed of the treadmill and to check the belt for proper operation.

JLL® recommends that the treadmill is unplugged or the On/Off power (I/O) is switched off (O) when not in use.

1. Without anyone on the machine, plug the treadmill in. Ensure the power cable is not being pinched under the front of the treadmill.
2. Locate the On/Off (I/O) power switch under the front end of the treadmill. Switch it to the on position (I). The display will light up.
3. The weight digits will flash. Adjust the weight using the SPEED buttons located on the handrail.
4. Press the START button and the treadmill will start at 0.3 km/h. Check if the monitor is working normally.
5. Observe the belt to see if it is running properly; it should be centred in the middle of the deck. If you have problems with the running belt operation, see Adjust Running Belt in the *Preventive Maintenance* chapter.
6. Press the + and - button to check whether they are working. Run the treadmill through its full speed range. First press the + button until the treadmill reaches its highest speed. Then press the - button until the treadmill is back to 0.3 km/h.
7. Press the STOP button and check if the machine stops working.

WARNING: FALLING HAZARD

When starting the unit:

- Stand on the side frames.
- Do not stand on running belt.













SPECIFICATIONS

Display	Blue backlit 5" LCD Displays: Time, speed, distance, heart-rate, calories, incline.
Programs	15 running programs.
Entertainment	High Powered Speakers, Smartphone/Tablet/MP3 Connectivity, USB interface.
Storage	Foldable and built-in wheels.
Quick Buttons	Quick Speed: 5, 8 km/h.
Safety	Emergency safety key, smooth start/stop function, safety handrail with speed and incline buttons, shock absorption system and security lock.
Speed	0.3 - 16 km/h (0.18 - 10mph)
Incline	20 levels
Controller	Digital micro-computer controller
Motor	DC Motor (Direct Current Motor)
Horsepower	Continuous power: 2.5HP (1800W), Peak Power: 4.5HP (3350W)
Power Rating	220 VAC 60 Hz
Working Temperature	5° C - 40° C
Running Area	122 cm (Length) x 41 cm (Width)
Maximum User Weight	120kg, 18.8 St or 152 lb.
Occupying Area	158 cm (Length) x 70 cm (Width) x 128 cm (Height)
Folded Area	100 cm (Length) x 70 cm (Width) x 141 cm (Height)
Packaging Dimensions	170 cm (Length) x 76 cm (Width) x 30.5 cm (Height)
Gross Weight	70kg
Net Weight	57.5kg

3 Operation

Read all instructions, warnings and safety procedures located in the *Safety* chapter before using the treadmill.

CONTROL SYMBOLS USED

	SET	Press to establish the setup parameters.
	STOP	During the middle of the workout press the button once to stop the running belt and pause the workout. This will also display the workout review. Press it twice to exit the workout and reset the readings.
	START	Press to start the running belt or start any selected program.
	FAST	Manually increase the speed of the running belt.
	SLOW	Manually decrease the speed of the running belt.
	INCLINE UP	Manually increase the incline of the treadmill.
	INCLINE DOWN	Manually decrease the incline of the treadmill.
	PROGRAM	Press to select your desired treadmill program.
	PLAY/PAUSE	Press once to play the audio of any linked device. Press again to pause it.
	SOUND+/NEXT	Play next track / Hold to increase volume.
	SOUND-/LAST	Play previous track / Hold to decrease volume.
	INSTANT SPEED 5	Set the speed of the running belt at 5 km/h.
	INSTANT SPEED 8	Set the speed of the running belt at 8 km/h.

SETUP

SETUP PARAMETERS

The treadmill should be completely stopped before accessing the Setup options.

1. On STANDBY mode, press SET button and all the numbers in the display area will become ZERO (0), except SPEED.
2. Press SET button several times to change different settings and the number in the display area will flash.
 - 2 times to change TIME.
 - 3 times to change SPEED.
 - 4 times to change DISTANCE.
 - 5 times to change HEART-RATE.
3. Press FAST or SLOW buttons to rectify the numbers.
4. Press START button to start or STOP button to cancel.

PAUSE/STOP

During the treadmill workout, press the STOP button once to stop the treadmill and keep the data recorded so far. If you press the STOP button again, all the digits on the display area will return to ZERO (0).

INCLINE SETUP

Before or during the treadmill workout, press the UP/DOWN incline button on the console or use the incline buttons on the handrail.

QUICK SPEED

On the side of the LCD there are two quick speed keys (5km/h and 8km/h). Press START and then any of them to change the speed automatically.

TOTAL DISTANCE SHOWN

With the treadmill in STANDBY mode and all data in the window displaying ZERO (0):

1. Press SET to show set data.
2. Press SET again and hold the button for 8 - 10 seconds to show the total distance.
This cannot be reset to zero.

EXIT SET UP MODE

Press the STOP button to exit Setup options.

STARTING THE TREADMILL

Maximum user weight is up to 120 kg, 18.9 St or 265 lb.

1. Switch on the treadmill.
2. Set up your weight to estimate calories burned.
3. Place each of your feet on the side frames located on each side of the running belt.
4. Clip the safety key onto your clothing and carefully test the safety key to ensure it will activate in case of an emergency. See *Safety Key* in the *Safety* chapter for proper testing of the safety key. Be sure the string is free of knots and has enough slack for you to run comfortably with the safety key in place.
5. Press START button.
6. Hold the handlebars while you step onto the running belt and begin walking.
7. Press the FAST or SLOW buttons to change the treadmill speed at any time. The left display will show the current speed.
8. Press the STOP button at any time to stop the running belt.

If the safety key is removed during a workout, the drive motor power shuts off immediately, causing the belt to stop.

When a workout is complete, the belt will slow down until it comes to a stop and a workout review will show on the display until you press the STOP button. The treadmill returns to STANDBY mode.

STOPPING THE TREADMILL

Press STOP once to pause the workout session. The treadmill will smoothly stop and the accumulated data will be displayed. Press STOP again to end the workout session.

EMERGENCY DISMOUNT

If you experience pain, feel faint or need to stop your treadmill in an emergency situation, simply pull the safety key off the console. The running belt will then immediately stop.

SAFETY KEY FUNCTION

The safety key functions as the emergency stop. In an emergency situation, remove the safety key from the treadmill and the running belt will stop.

HEART-RATE SENSORS

Hold the sensor plates on the handlebar ensuring that hands are clean. A heart-rate reading will show on the display. Factors that interfere with pulse signal are:

- Hand lotions, oils or body powder
- Excessive dirt
- Excessive movement

 NOTE: Calories and heart-rate share the same window on the LCD screen. Calories are always shown on the display, but for the heart-rate you have to hold the sensor plates on the handlebar for display.

 NOTE: Heart-rate is calculated by PPM (Pulsations per minute) not BPM (Beats per minute).

 NOTE: The pulse reading is only for your reference and will not be 100% accurate.

DATA READOUTS

As you exercise, the treadmill keeps track of the following data:

- **Time:** The total time you have been working out or time remaining. Display time as hours: minutes.
- **Speed:** Your current speed, displayed in kilometres per hour (km/h).
- **Distance:** The total accumulated distance, in kilometres during your workout.
- **Calories:** The total accumulated calories burned during your workout.
- **Heart-rate:** Your current heart-rate. Heart-rate will appear when a signal is detected. Use the hand sensors to display your heart-rate.
- **Weight:** Your current weight, displayed in kilograms (kg).
- **Incline:** Your current incline, displayed in percentage (%).

ENTERTAINMENT

PLAY YOUR MP3/SMARTPHONE/TABLET DEVICE

Connect your MP3 device into AUX port. Place your device onto the tray. Operate from your own device to change the song and the volume.

USB AUDIO INTERFACE

To play music via the USB port, you must have all music files in MP3 format and in a folder titled 'MUSIC' on a USB flash drive.

1. Connect the USB flash drive into the USB port on the console. The music will start playing automatically.
2. Press PREVIOUS/VOL+ to change to the next song.
Press and hold it to increase the volume.
3. Press NEXT/VOL- to change to the previous song.
Press and hold it to decrease the volume.

PROGRAMS

Each program is made up of 10 sections of 200m. At each 200m interval the speed/incline may change. If the Play/Pause button is pressed throughout any program this will stop the program and will not be resumed from it's current stage. Once the tenth section has been completed the program will loop to start from section one again unless STOP is pressed.

CUSTOM PROGRAMS

The first 3 programs on the treadmill are customisable which gives you complete control over your workout. Follow these steps to customise a program:

1. On STANDBY mode, press and hold PROGRAM once for P01, twice for P02 and three times for P03.
2. Press FAST or SLOW to set up the speed.
3. Press INCLINE UP or INCLINE DOWN to set up the incline.
4. Press SET to save the first section.
The console will display 2 in the distance section.
5. Repeat this process until you complete all 10 sections.
6. Press SET to save the changes.

HEART-RATE CONTROL PROGRAM

With the treadmill in STANDBY mode and all data displaying ZERO (except WEIGHT):

1. Press SET button 5 times. The heart-rate will show on the display area.
2. Press FAST or SLOW button to amend this number.
3. Press START button to start or STOP to cancel.
4. Hold the sensor plates on the handlebars to obtain heart-rate reading.
5. The machine will adjust the speed to reach the pulse that you set up. If the heart-rate is lower, the speed will increase. If it's higher, the speed will decrease.

PRESET PROGRAMS

Use the PROGRAM button to select one of the preset programs detailed on the following page:

PROGRAM 13

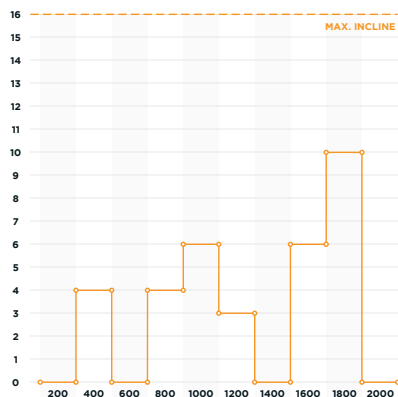

PROGRAM 14

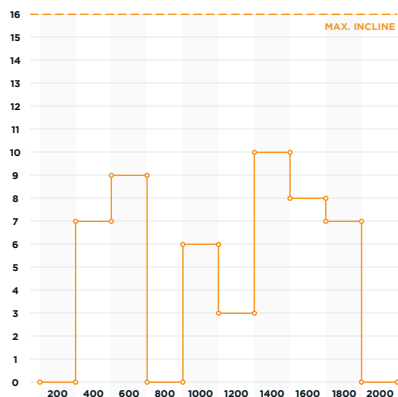

PROGRAM 15

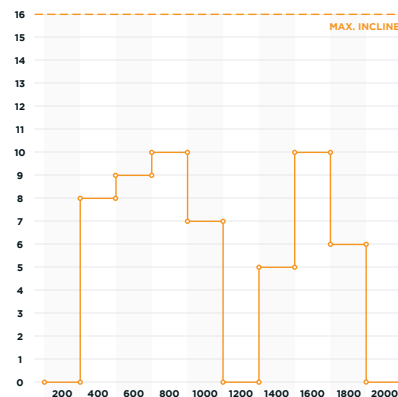

SPEED (KM/H) AND INCLINE RUNNING PROGRAMS

Section		200	400	600	800	1000	1200	1400	1600	1800	2000
PO 1	Speed	3.8	4.8	5	5.6	6	5.8	7	5	4.6	3.9
	Incline	0	3	5	3	4	3	0	3	5	0
PO 2	Speed	3.8	4.6	5.6	6	7	8	7	6	5	4.6
	Incline	0	3	4	6	3	5	3	6	3	0
PO 3	Speed	3.9	5.2	6.6	8	9	5	7	6	5.2	4.6
	Incline	0	4	0	4	6	3	0	6	10	0
PO 4	Speed	4.2	5	7	9	12	5	8	10	5	4.2
	Incline	0	7	9	0	6	3	10	8	7	0
PO 5	Speed	4.2	5.2	7	5	7	6	12	5	4.6	4.6
	Incline	0	8	9	10	7	0	5	10	6	0

SPEED ONLY RUNNING PROGRAMS (KM/H)

Section	200	400	600	800	1000	1200	1400	1600	1800	2000
PO 6	3.8	4.8	5	5.6	6	5.8	7	5	4.6	3.9
PO 7	3.8	4.6	5.6	6	7	8	7	6	5	4.6
PO 8	3.9	5.2	6.6	8	9	5	7	6	5.2	4.6
PO 9	4.2	5	7	9	12	5	8	10	5	4.2
PO 10	4.2	5	10	5	8	6	12	5	7	4.6

INCLINE ONLY RUNNING PROGRAMS

Section	200	400	600	800	1000	1200	1400	1600	1800	2000
PO 11	0	3	5	3	4	3	0	3	5	0
PO 12	0	3	4	6	3	5	3	6	3	0
PO 13	0	4	0	4	6	3	0	6	10	0
PO 14	0	7	9	0	6	3	10	8	7	0
PO 15	0	8	9	19	7	0	5	10	6	0

4 Maintenance

Maintenance must be performed on a regular basis. Performing maintenance actions can aid in providing safe and trouble-free operation of all JLL® equipment.

JLL® are not responsible for performing regular inspection and maintenance actions for your machine. JLL® representatives are available to answer any questions that you may have on +44 (0)800 6123 988.

PREVENTIVE MAINTENANCE ACTIVITIES

Every JLL® treadmill that comes from the factory is already lubricated, however, you just need to follow simple steps to maintain it. Keeping the treadmill in a clean state will help to prolong its life. Perform regular preventive maintenance to ensure normal operation of the unit. Keep a log of all maintenance actions to assist in staying current with all preventive maintenance activities. JLL® is not responsible for performing regular inspection or maintenance.

PLEASE NOTE: Factors such as where the item is stored and how often the machine is used will affect the length of time between the necessary maintenance. It is recommended to perform this maintenance every six weeks. Details of how to perform the maintenance can also be found on our support center.

Read all instructions and warnings listed both in this chapter and in the *Safety* chapter. During maintenance, disconnect the power cable. Contact JLL® Customer Service on +44 (0)800 6123 988 for any maintenance or service concerns.

Requirements:

- Water
- Dry cloth
- Allen key
- Vacuum
- Lubrication oil



Scan the QR code to view our maintenance tutorial video.

Depending on where the treadmill is placed, you may experience dry air, causing a common experience of static electricity. You can notice that by walking across a carpet and then touching a metal object. On your treadmill you may experience a shock due to the build-up of static electricity on your body and the discharge path of the treadmill. If you experience this type of situation, you may want to increase the humidity to a comfortable level through the use of a humidifier.

Check your machine regularly for rust. If rust starts to appear on the screws it means the item is not housed in the correct environment and will need to be moved to a more suitable room. Any rust will indicate there may be moisture in the air and as a result this could impact on the integrity and performance of your machine.

TREADMILL CLEANING

Keep the running belt free of dust and debris for smooth running and preventing injuries. Dust/debris may cause damage to the electric motor and other moving parts. Over time the motor will pull in dust/debris so it is advised every so often when maintenance is being performed to remove the motor cover and vacuum out of the motor.

After every workout use a neat, dry cloth for cleaning the treadmill and the handlebars to prevent the machine of corrosion. Wipe away any sweat that may have dripped onto the running belt. Avoid scratching the display by using a soft cloth.

Contaminants, such as hand lotions, oils or body powder, may come off on the sensor plates. These can reduce sensitivity and interfere with the pulse signal. It is recommended that the user has clean hands when making contact with the sensor plates. Clean the handles using a cloth dampened with water.

For cleaning the console unplug the machine and clean with a dust free cloth. For further cleaning, use a soft cloth or paper towel dampened with water. Do not use abrasive or chemical cleaning agents.

When not using product for an extended period of time the product should be disconnected from the power supply.

⚠ WARNING

1. Only use water to clean and dust. Do not use any cleaning product because they may damage the treadmill.
2. Be careful not to spill or get excessive moisture between the edge of the display panel and the console, as this might create an electrical hazard or cause failure of the electronics.
3. Direct spraying could cause damage to the electronics and may void the warranty.

⚠ WARNING

1. Use only JLL® replacement parts.
2. Unplug unit and let sit 10 minutes before cleaning or performing maintenance.
3. Keep water and liquids away from electrical parts.
4. Electrical charge can remain in unit after unplugging.
5. If you allow your machine to become rusty, this will affect your warranty.

⚠ WARNING: EQUIPMENT HAZARD

To avoid serious injury or death:

- Replace worn or damaged components immediately and do not use until repair is completed.
- Unplug unit when not in use or when performing regular maintenance.

TREADMILL BALANCE

Place the treadmill on a level floor to avoid it being off-balance. If that is not possible, adjust the treadmill by adjusting the rubber feet located underneath the frames.

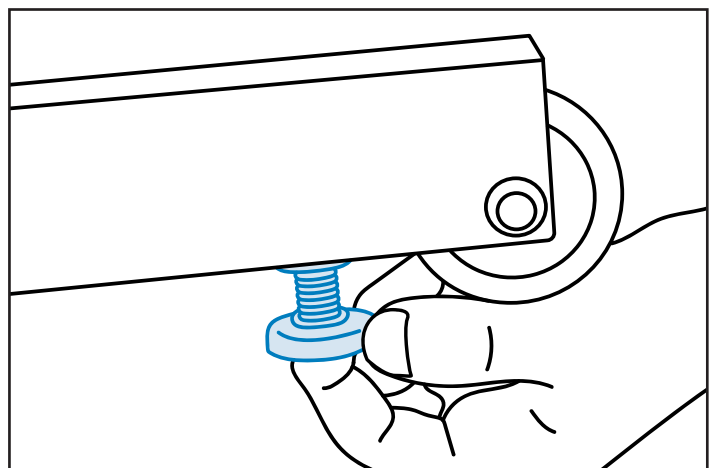

Check if the treadmill is balanced:

1. Stand on the machine with your feet on the side frames.
2. Put your weight on the right side first and then switch to the left side.
3. If you feel any vibrating whilst using the treadmill, adjust the rubber feet located at the base of the frame.

TREADMILL LUBRICATION

If the level of friction between the deck and the belt is high, it will damage the motor and electronics. The running board must be lubricated by a special lubrication oil after a period of usage. A well-lubricated treadmill will be smooth when running and will last longer.

Recommendation (these are just a guideline):

- Less than 3 hours per week of use: Lubricate it every 6 months.
- 3-6 hours per week: Lubricate it every 3 months.
- More than 6 hours per week: Lubricate it every month.

5 STEPS TO LUBRICATE YOUR TREADMILL

1. Unplug the treadmill.
2. To get access to the deck lift the belt on the treadmill up with your fingers or with something flat and not sharp.
3. Look at the running board or touch it to check if it is oily or not. In case of dryness, use the lubrication oil provided and apply it on the running deck by spreading a

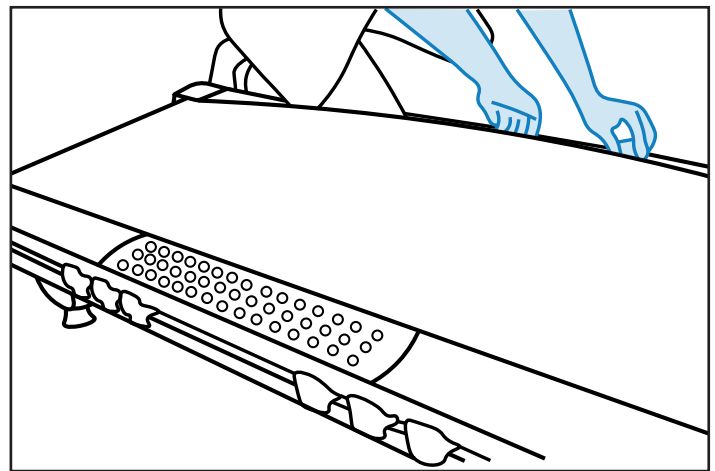

- straight line down the side of the deck. Ensure that the middle of the board is lubricated.
4. Repeat on the other side.
5. Turn on the machine and leave it running for around 2-3 minutes at 3-4 km/h. Walk on the treadmill to help spread the lubrication oil.

ADJUSTING THE RUNNING BELT

After a period of time, the user will feel there is a pause sensation whilst running. The running belt can become loose and stretch a bit over time causing a slipping sensation if it is not adjusted and tightened when needed.

If the belt is too tight, this may cause damage to your motor and/or roller. A belt too loose or too tight can cause wear and tear of both the belt and the board.

HOW TO CHECK IF THE RUNNING BELT IS LOOSE

You can check this every time you use the treadmill by setting the speed to 2-3 km/h then walking on the machine and try to stop the running belt with your feet while holding the handlebars and pulling your body in the opposite direction. If the belt stops, it means that it is loose and needs to be tightened.

Another way is checking if the gap between the running belt and the running board is smaller than 5-6 mm, that means that the running belt is loose.

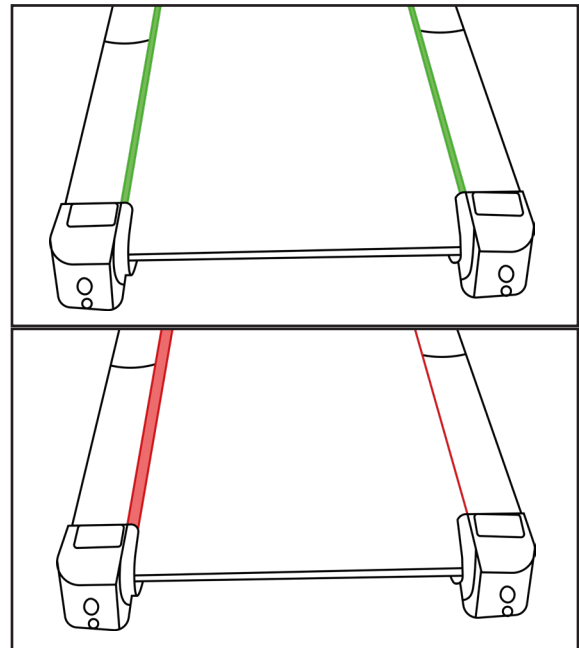

TIGHTENING THE RUNNING BELT

1. Power off the treadmill.
2. Turn the two belt adjustment screws, located at the rear, clockwise to tighten the belt slightly by quarters.
3. Get back on the treadmill and check the belt (read description above). If it is still loose, re-adjust the belt screws by another quarter until you get the required tension on the belt.
4. Run the machine on its own for 1-2 minutes to see if the belt stays in the middle.

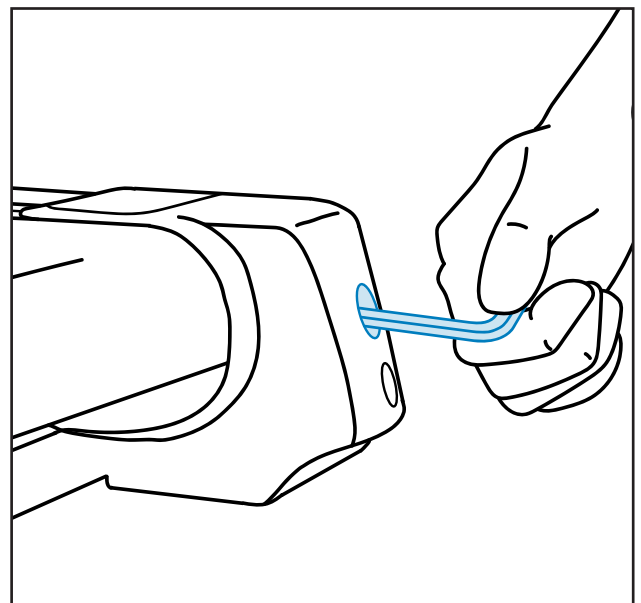

5. Do the final test. Leave the machine running for a couple of minutes at 6-8 km/h.
6. If the running belt stays in the centre, you can use the treadmill straight away.

ADJUSTING THE BELT WHEN IT IS NOT CENTERED

Usually between the frames and the running belt there should be a gap of 5-6 mm on both sides. If that gap is different it means that the belt is eccentric. So you have to put it back to the right position by following these steps:

1. Power on and set the speed at 2-3 km/h and adjust the screw at the end of the treadmill slowly with the Allen key.
2. If the belt slants to the left, adjust the left bolt clockwise or adjust the right bolt anti-clockwise. If the belt slants to the right, adjust in the opposite manner.
3. While adjusting the belt, check if the gap of difference has disappeared, if it is still there, screw the bolt again. Repeat this procedure until the running belt is in the centre. It does not need to be aligned perfectly, but ensure it is not scraping or rubbing on anything on the sides.
4. Set the speed at 6 km/h to check if the running belt is still in the same position. Once you have checked that, the treadmill is ready to use.

ADJUSTING THE MOTOR BELT

After a period of time, the user will feel there is a pause sensation whilst running. That may be due to a loose motor belt, so adjusting it would be necessary. First of all, you have to check if it is loose following the steps below.

HOW TO CHECK IF THE MOTOR BELT IS LOOSE

1. Unplug the treadmill.
2. Remove the motor cover by unscrewing the bolts on each side. You will see the motor located on the left hand side of the treadmill.

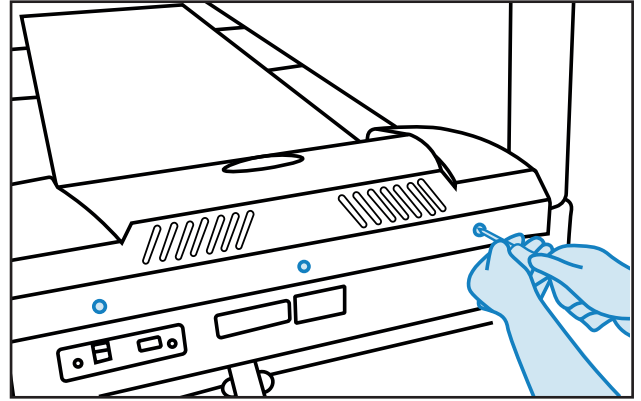

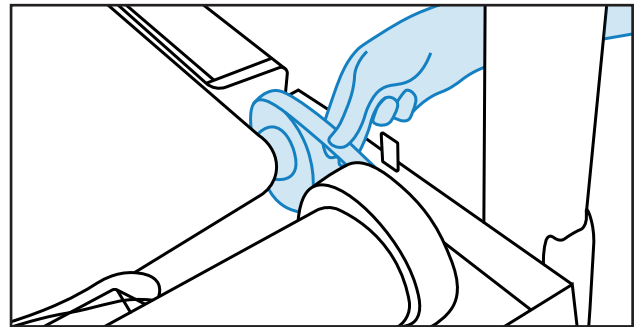

3. An easy way of checking is by touching the drive belt to feel if it is slack. If you can wiggle the belt up and down, it means that the drive belt is loose.
4. You can check this every time you use the treadmill by setting the speed to 2-3 km/h then walking on the machine and try to stop the belt with your feet while holding the handlebars and pulling your body in the opposite direction. If the motor stops, it means that it is loose and needs to be tightened.

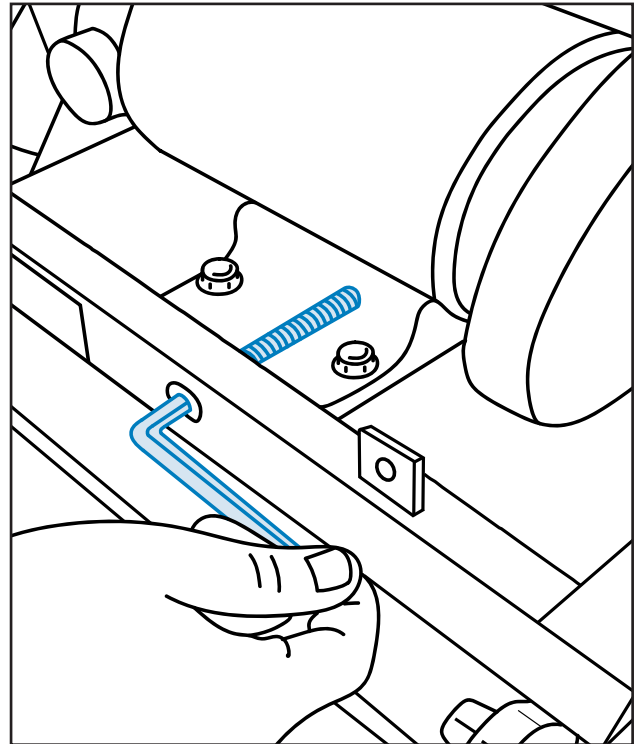

TIGHTENING THE MOTOR BELT

1. Ensure that the treadmill is unplugged from the power source.
2. Locate the four bolts holding the motor.
3. Loosen those four bolts, but do not remove them.
4. Locate the long tensioning bolt that goes from the front edge of the treadmill to the front edge of the motor pallet.
5. Turn the Allen key clockwise to tighten the tensioning bolt just enough to stop it from slipping.
6. Check the tension on the motor belt.
7. Power on the machine and check if the motor belt is still loose (See previous chapter).



 NOTE: Do not tighten the motor belt too much as this could cause the motor shaft to snap.

5 Additional Information

CONTACT INFORMATION

In case any issues arise, please do not hesitate to contact our Customer Service team on +44 (0)800 6123 988 or email us at **CONTACT@JLLFITNESS.CO.UK**

You can also visit our support centre at **SUPPORT.JLLFITNESS.CO.UK** for maintenance and assembly articles & videos.

DISCLAIMER

- You should consult your physician, doctor or other health care professional before starting or taking part in any of our workout guides. It is your responsibility to evaluate your own health before taking part or performing any physical activity you may see associated with JLL Fitness Ltd.
- Always seek professional advice before changing your diet or starting any exercise program.
- JLL Fitness Ltd is not liable for any injuries or damages that may occur when assembling or using this treadmill.
- Users must be cautious when using the top speeds on this treadmill.
- By reading this you assume full responsibility for any injuries or changes to your physical well-being. You waive all rights and release JLL Fitness Ltd of blame from any injuries or damages to property that may occur whilst following our advice.
- This manual offers specific instructions on how to assemble and maintain your treadmill. Failure to follow these directions may result in your warranty being void.

WWW.JLLFITNESS.COM

Follow us on Facebook and Twitter [@JLLFitness](#)

© JLL Fitness Ltd . All Rights Reserved.